

MAS 640SS Instruction Manual



MAS Advanced Measurement Solutions

www.massensors.com

Table of Contents

1. Introduction.....	3
2. Specification.....	3
2.1. General Technical Data	3
2.2. Applications.....	4
2.3. Technical Data A/D Converter.....	4
3. Putting Into Operation.....	5
3.1. Opening The Instrument.....	5
3.2. Connecting a Weighing Platform.....	5
3.3. Connecting to the Serial Interface	6
4. Basic Functions.....	7
4.1. User Interface.....	7
4.2. Operation Keys	7
4.3. Note On Stability	8
4.4. Front Panel Annunciators (LEDs).....	9
4.5. Switching the Instrument On and Off.....	9
4.6. Zeroing.....	9
4.7. Simple Weighing.....	9
4.8. Weighing with Tare.....	10
4.9. Printing/transferring data.....	10
5. Special Functions.....	10
5.1. Special Function Keys.....	10
5.2. Counting.....	10
5.3. Setting a Filtering Level.....	11
5.4. Accumulate Weighing.....	11
5.5. Printout Select.....	11
5.5.1. Printout Select Options.....	12
6.6.1. Autozero/Zero Tracking Options.....	13
5.7 Check Weighing.....	13
5.7.1. Check weighing Option Table.....	13
6. Setup.....	13
6.1. Entering the Setup Mode.....	13
6.2. Main Menu Setup Functions.....	14
6.2.1. Switching Between Setup Functions from Main Menu.....	15
6.2.2. Editing Function Content.....	15
6.2.3. Accepting or Canceling Changes	16
6.3. Example Setup Table for Single Interval Weight Measurements.....	16
6.4. Example Setup Table for Two Interval Weight Measurements.....	16
7. Calibration Routines	17
7.1. Zero Calibration.....	17
7.2. Span Calibration.....	18
8. Saving Changes.....	19
9. Leaving Setup mode	19
10. Error Messages Table.....	20

1. Introduction

The weight indicator MAS 640SS was designed for fast and accurate, high resolution measurements. Its performance is based on a 24 bit delta sigma A/D converter. Water resistant housing allows this instrument to work under very demanding industrial environments with years of constant quality.

This manual provides technical specification as well as instructions for setup and use of the instrument.

2. Specification

2.1. General Technical Data

Main display	7 segment LED display, 6 numbers, 20 mm high
Housing	Stainless steel, protection class IP65
Power Supply	85 - 240 VAC, 50-60Hz, 10W
Data Interface	RS232
Operating Temperature	-10°C... +40 °C
Storage Temperature	-20°C...+60 °C
Relative Humidity	10...85 %, non condensing
Weight	Approx 2 kg

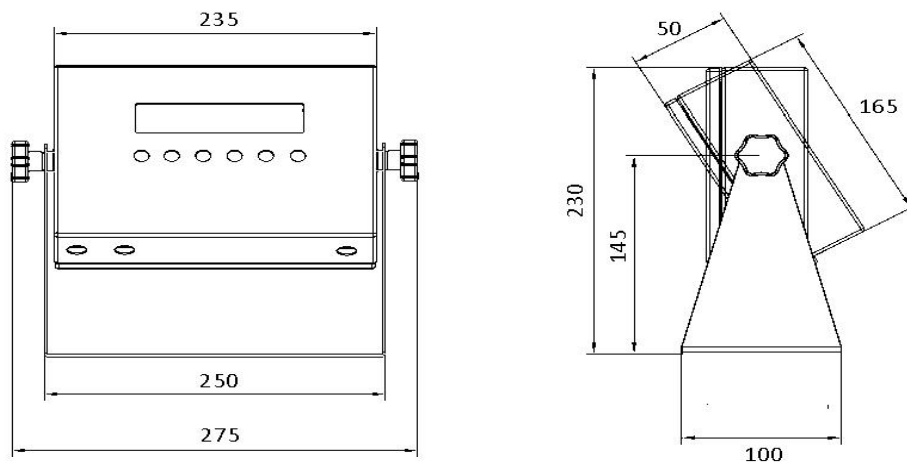

Figure 1: Instrument's case dimensions in mm.

2.2. Applications

Weighing functions	<ul style="list-style-type: none"> ● Simple weighing ● Check weighing ● Zero setting, Zero tracking, Autozero ● Taring, Clearing tare ● Counting ● Accumulation
Optional functions	<ul style="list-style-type: none"> ● Barcode printers connection ● Barcode scanner connection ● AC relay/DC relay output ● 0-10V output ● 4 -20 mA output

2.3. Technical Data A/D Converter

Load cell excitation voltage	+5V DC
Load cell drive	Up to 8 x 350 Ohm load cells
Maximum displayed resolution	1 : 60.000 d
Maximum number of VSI*	6000
Measurement Update Rate	10 Hz
Measuring range maximum voltage	15mV
Minimum input voltage per VSI*	1µV

* verification scale interval

3. Putting Into Operation

3.1. Opening The Instrument

WARNING!

Before opening the instrument disconnect the power cord from the power supply.

To open the instrument unscrew the 8 screws from the back and lift the cover.

3.2. Connecting a Weighing Platform

- Insert the weighing platform cable into the instrument through the cable gland
- Connect the weighing platform cable to the J3 terminal according to the table below.

Pin	1	2	3	4	5	6
Assignment	SIG+	SIG-	EXC+	EXC-	REF+	REF-

Note:

For 4 wire loadcells the J1 and J2 pads should be bridged with a solder or Ref+ and Ref- should be connected to EX+ and EX- respectively.

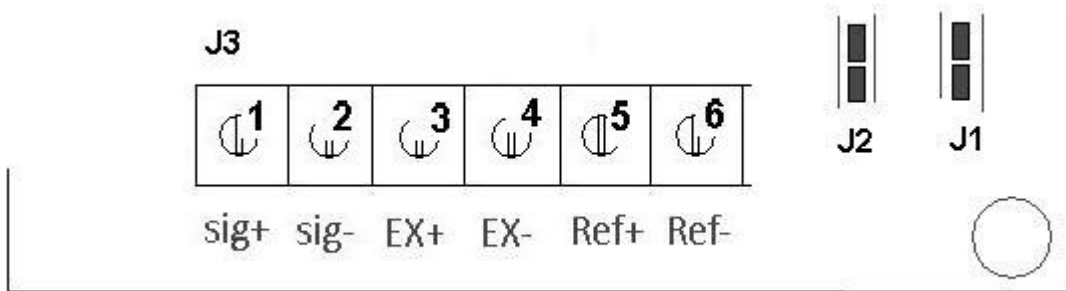

Figure 2: Location of the J3 terminal on the digital module inside the instrument.

3.3. Connecting to the Serial Interface

- Insert the interface cable into the instrument through the cable gland.
- Connect the interface cable to the J10 (3-pin terminal) according to the table below.

Pin	3	2	1
Assignment	Rxd	Gnd	Txd

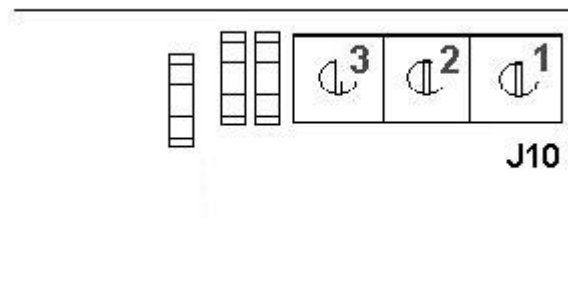

Figure 3: Location of the J10 terminal on the digital module inside the instrument.

Default parameters are: 4800 bps, 8 data bits, no parity, one stop bit, no handshake.

4. Basic Functions

4.1. User Interface

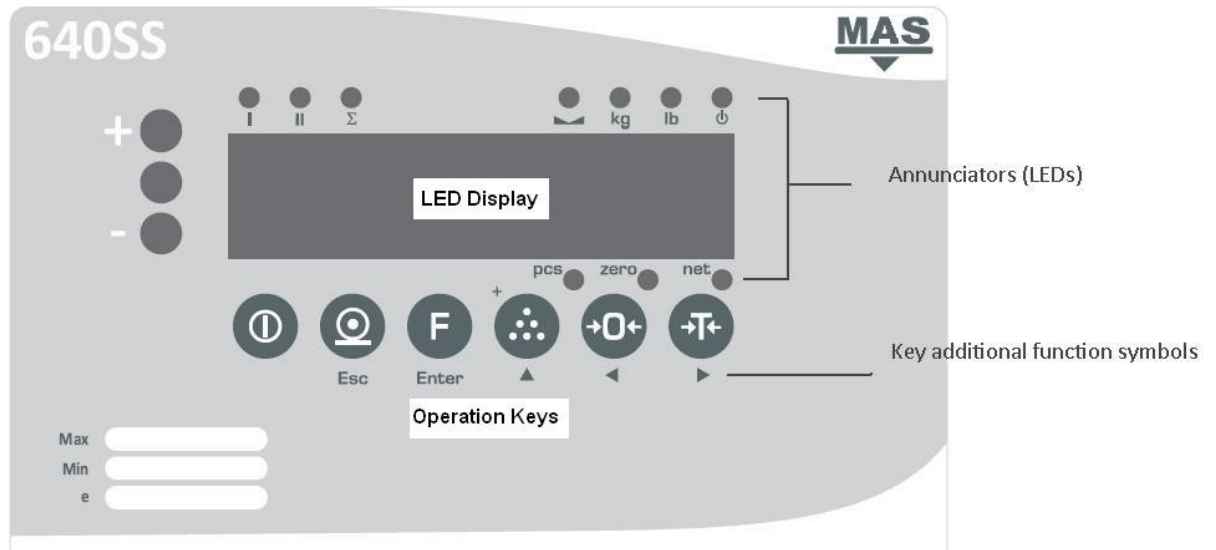









Figure 4: Front panel interface.

4.2. Operation Keys

KEY	DESCRIPTION
 <POWER>	The <POWER> key is used to turn the instrument on and off.
 <ZERO>	The <ZERO> key is used to execute zero level adjustment. Use the <ZERO> key once empty scale has drifted away from the zero reading.

  <TARE>	The <TARE> key is used to display zero on the display when an empty container is placed on the weighing platform. Use the <TARE> key to cancel mass of an empty container
 Enter <FUNCTION>	The <FUNCTION> key is used to select one of the special function. Refer to the Special Functions [section 5.] for the details on the available functions.
  <PIECES>	The <PIECES> key activates counting pieces of similar weight like screws, nails, etc. A long press of the <PIECES> key is used to declare the number of sample pieces used as a reference for counting. For more details on how to use this function refer to the Special Functions [section 5.].
 Esc <PRINT>	The <PRINT> key sends the current status to a connected printer allowing a printout of the displayed stable readings, i.e. weight, total weight, number of pieces. Please note, readings must be stable on the display before printing.

4.3. Note On Stability

The Unit has to wait for stable readings when the <ZERO>, <TARE> or <PRINT> key is pressed. That way execution of associated operation may be delayed by a few seconds. Readings are stable when you see the LED of stable reading symbol [section 4.4] highlighted.
 If readings are unstable for more than 10 seconds message error -E06- will be displayed and printing operation will be canceled.

4.4. Front Panel Annunciators (LEDs)

Symbols on the front panel	Description
I, II	Indicates which one of two ranges is actually in operation
Σ	Indicates that total weight is being displayed
▾	Indicates stable readings for weighing or counting
kg, lb	Indicates unit of weight measurements
pcs	Indicates that the instrument is working in counting pieces mode
zero	Indicates that instrument is at zero reference level
net	Indicates that Net values are being displayed
⏻	Indicates the standby mode

4.5. Switching the Instrument On and Off

- Press the <POWER> key to turn on the instrument.
The display lights up, serial number appears and the instrument performing a self test.
- Press the <POWER> key once instrument is in the operation to switch to the standby mode.
The standby mode is indicated by the standby LED.

Warning:

While in the standby mode the instrument is still connected to AC mains power supply. During the maintenance disconnect instrument's power supply plug from the wall socket.

4.6. Zeroing

- Unload weighing platform.
- Press the <ZERO>key.

Zero level is indicated by lighting up the zero LED placed just above the <ZERO> key.

4.7. Simple Weighing

- Press the <ZERO> key to light up **zero** annunciator if needed.
- Place the weighing sample on the weighing platform.
- Wait until **stab.** annunciator is on.
- Read weighing result.

4.8. Weighing with Tare

Place the empty container on the weighing platform and press the <TARE> key. Instrument will cancel a container mass by displaying zero.

On the main display, after canceling a container mass, the **net** LED will light up just above the <TARE> key to indicate the Net weight readings.

To cancel tare effect press the <TARE> key once instrument's readings are zero or below zero.

4.9. Printing/transferring data

- Press the <PRINT> key.

The display contents are printed out or transferred to a computer. Refer to the section 5.5 for the available printout options.

Note:

Unstable readings will not be printed out or transferred to a computer.

5. Special Functions

5.1. Special Function Keys

Special functions are accessed through the Operation Keys. Follow the symbol under each Operation Key to recognize its additional function.

5.2. Counting

- Place the container on the weighing platform and press the <TARE> key if needed.
- Place the known number of sample pieces to be counted into the container.

Note: The greater sample number and weight, the more accurate are the counting results.

- A long press the <PIECES> key, then set the number of sample pieces to be loaded with the <TARE>, <ZERO> or <PIECES> keys, according to the arrow markings under each key.
- Accept changes by pressing the <FUNCTION> key.
- Read the number of peaces after **stab** annunciator lit.

To exit counting mode short press the <PIECES> key. Unit will go back to the weighing mode.

Note: Once the number of sample pieces is stored by the unit memory there is no need to load the sample pieces again until a different item is to be counted.

User can simply toggle between counting mode and weighing mode by short pressing the <PIECES> key. If there is no sufficient load of sample pieces during counting mode unit displays the message error -E08-.

5.3. Setting a Filtering Level

- Press the <FUNCTION> key.
- Press the <PIECES> key repeatedly until message 'AuE' displayed.
- Press the <FUNCTION> key to enter filtering sub menu.
- Change the last digit blinking from 0 to 3 to adjust strenght of the filter.
- Accept changes by pressing the <FUNCTION> key.

Filtering Level:	Description:
0	background FIR filtering
1	mild average
2	strong average
3	very strong average

5.4. Accumulate Weighing

- Press the <FUNCTION> key.
- Press the <PIECES> key repeatedly until message totAL displayed.
- Press the <FUNCTION> key to enter Accumulate Weighing sub menu.
- Change the last digit blinking to 0 or 1 to disable or enable Accumulate Weighing respectively.
- Accept changes by pressing the <FUNCTION> key.

5.5. Printout Select.

- Press the <FUNCTION> key.
- Press the <PIECES> key repeatedly until message 'SE' displayed.
- Press the <FUNCTION> key to enter Printout Select sub menu.
- Change the last digit blinking for 1,2,3 or 4 with the <PIECES> key. Refer to the Printout Select Options' table [5.5.1] for more information.
- Accept changes by pressing the <FUNCTION> key.

5.5.1. Printout Select Options

No	Description
1	Net weight only printout. Example: N: 12.4 kg
2	Net and Gross weight printout. Example: N:12.4 kg G:13.0 kg
3	Net, Gross and Tare weight printout . Example: N: 12.4 kg G: 13.0 kg T: 0.6 kg
4	Net weight and Total weight printout . Example: <pre> N: 12.4 kg SUM: 12.4 kg ----- #1 N: 12.0 kg SUM: 24.4 kg ----- #2 N: 10.1 kg SUM: 34.5 kg ----- #3 </pre>
5...9	Label data printout (option).

5.6. Autozero / Zero Tracking Select

- Press the <FUNCTION> key.
- Press the <PIECES> key repeatedly until message 'AZER' displayed.
- Press the <FUNCTION> key to enter Autozero/Zero Tracking Select sub menu.
- Change the last digit blinking for 0,1 or 2 with the <PIECES> key. Refer to the Autozero/Zero Tracking Options table [5.6.1] for more information.
- Accept changes by pressing the <FUNCTION> key.

6.6.1.Autozero/Zero Tracking Options

Autozero option No.	Description:
0	Disable Autozero and Zero tracking
1	Enable Zero tracking only
2	Enable Zero tracking and Autozero

5.7 Check Weighing

- Press the <FUNCTION> key.
- Press the <PIECES> key repeatedly until message 'ChE' is displayed.
- Press the <FUNCTION> key to enter Check Weighing sub menu.
- Change the last digit blinking for 0,1 or 2 with the <PIECES> key. Refer to Check Weighing Select Options table [5.7.1] for more information.
- Accept the changes by pressing the <FUNCTION> key.

5.7.1. Check weighing Option Table

Check weighing option No.	Description:
0	Disable Check weighing
1	Enable Check weighing
2	Enable check weighing with a new settings

6. Setup

6.1. Entering the Setup Mode

To enter the setup mode:

- Disconnect the indicator from the power supply.
- Remove the instrument back cover. Move the jumper on the digital module from the position J9 to J8 [Figure 5.].
- Turn the power on.
- Once display shows the 'iuPER' message, move the jumper on the digital module from the position J8 to J9.



The display will light 'SET' message as shown. Now you can select any function from Main Menu Setup Functions [6.2.] by pressing repeatedly the <PIECES> key.

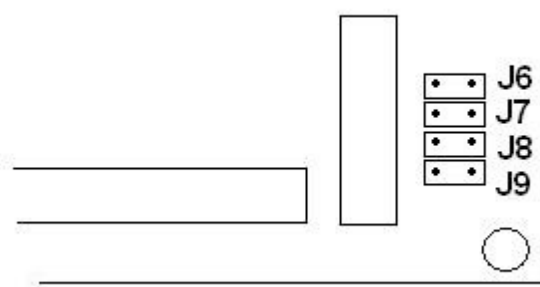

Figure 5: Location of the J8, J9 jumpers on the digital module inside the instrument.

6.2. Main Menu Setup Functions

See the Table below for available functions.



Firmware version A0.01

Function name	Description
dP	Setting position of decimal point for display readings. Allowed numbers: 0 to 3. 0 – no decimal point. 1,2,3 – n position from right end of the display. Example: Dp = 3; the display zero reading is: 0.000 Dp = 2; the display zero reading is: 0.00
di1	Value of the least significant digit for the first interval. Allowed numbers : 1,2,5,10,20,50. Example: Once di =1 is chosen, every reading in the least significant position of the displayed value will be changed by 1. Once di = 5 is chosen, every reading in the least significant position of the displayed value will be changed by 5, etc.
di2	Value of the least significant digit for the second interval see description for di1 function.
FU1	Setting the maximum value for the first measuring interval. Maximum allowed number is 99999.
FU2	Setting the maximum value for the second measuring interval. Maximum allowed number is 99999.
E	Setting the value of the load the unit will be adjusting (calibrating) with. Maximum allowed number is 99999. E should be no more than value at FU2 .
ZEROCAL	No load calibration. This level will be recognized by the instrument as a zero reference.
SPAnCAL	Span calibration at a load declared in E function
SAuE	Savings parameters to nonvolatile memory.

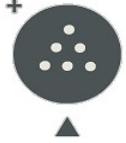

6.2.1. Switching Between Setup Functions from Main Menu

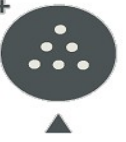
<p>To switch between the different functions of the Main Menu press the <PIECES> key repeatedly.</p>	 <p><PIECES></p>
--	---

6.2.2. Editing Function Content

<p>To edit content of a chosen function press the <FUNCTION> key while function name is displayed. The flashing digit and the function name will light on the display.</p>	 <p>Enter <FUNCTION></p>
<p>To change the content of a chosen function use the <PIECES> key to increment the value of the flashing digit.</p>	 <p><PIECES></p>
<p>Use the <ZERO> or <TARE> keys to move the flashing digit position to the left or right respectively.</p>	 <p><ZERO></p>  <p><TARE></p>

6.2.3. Accepting or Canceling Changes

<p>To accept the changes press the <FUNCTION> key and chose another function from the Main Menu.</p>	 <p>Enter <FUNCTION></p>
<p>Press the <PRINT> key to cancel any changes within chosen function and go back to the Main Menu.</p>	 <p>Esc <PRINT></p>

6.3. Example Setup Table for Single Interval Weight Measurements

Max Cap[kg]	n	d	dP	diu	div2	FU1	FU2	E<=FU2 (example value)
1	10000	0.1g	1	1	1	10000	10000	10000
3	6000	0.5g	1	5	5	30000	30000	30000
6	3000	2g	0	2	2	6000	6000	6000
15	3000	5g	3	5	5	15000	15000	10000
30	3000	10g	2	1	1	3000	3000	2000
60	3000	20g	2	2	2	6000	6000	6000
150	3000	50g	2	5	5	15000	15000	10000
300	3000	100g	1	1	1	3000	3000	1500
600	3000	200g	1	2	2	6000	6000	3000
1500	3000	500g	1	5	5	15000	15000	1000
3000	3000	1kg	0	1	1	3000	3000	2000









6.4. Example Setup Table for Two Interval Weight Measurements

Max Cap[kg]	n*	d	dP	diu	div2	FU1	FU2	E <= FU2 (example value)
3/6	6000	1g/2g	0	1	2	3000	6000	6000
6/15	7500	2g/5g	0	2	5	6000	15000	10000
15/30	6000	5g/10g	0	5	10	15000	30000	15000
30/60	6000	10g/20g	2	1	2	3000	6000	10000
60/150	7500	20g/50g	2	2	5	6000	15000	10000
150/300	6000	50g/100g	1	5	10	15000	30000	15000
300/600	6000	100g/200g	1	1	2	3000	6000	3000
1500/3000	7500	500g/1000g	1	5	10	15000	30000	15000







* scale intervals

7. Calibration Routines

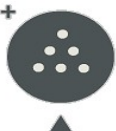

7.1. Zero Calibration

 <p>After entering the setup mode [section 6.1] repeatedly press the <PIECES> key until ZerCAL is displayed.</p>	 <p><PIECES></p>
<p>Make sure that there is no load at the weighing platform.</p>  <p>Press the <FUNCTION> key. ZerCAL will start to flash. Press the <FUNCTION> key again and the calibration will start.</p>	 <p>Enter</p> <p><FUNCTION></p>
 <p>During the calibration the display shows the internal count reading at the zero level. Once the reading is stable you can accept it by pressing the <FUNCTION> key.</p>	 <p>Enter</p> <p><FUNCTION></p>
 <p>Wait until program return to the main menu setup displaying ZerCal. Press the <PIECES> key to select another function from the main menu setup.</p>	 <p><PIECES></p>

7.2. Span Calibration

 <p>After entering the setup mode [see 6.1] repeatedly press the <PIECES> key until SPAn is displayed.</p>	 <p><PIECES></p>
 <p>Make sure the weighing platform is loaded by a load of weight declared in the E function of the main menu. Press the <FUNCTION> key. SPAn will start to flash. Press the <FUNCTION> key again and span calibration will start.</p>	 <p>Enter</p> <p><FUNCTION></p>
 <p>During the calibration the display shows the internal count reading at the span level. Once the reading is stable accept it by pressing the <FUNCTION> key.</p>	 <p>Enter</p> <p><FUNCTION></p>
 <p>Wait until the program return to the main menu displaying SPAn and press the <PIECES> key to select another function from the main menu.</p>	 <p><PIECES></p>

8. Saving Changes

 <p>In the main menu setup, press the <PIECES> key repeatedly until 'SauE' is displayed.</p> <p>Accept the savings by pressing the <FUNCTION> key.</p>	 <p>< PIECES ></p>  <p>Enter <FUNCTION ></p>
--	--

9. Leaving Setup mode

After completion of all the adjustments select the 'SAuE' function from the main menu and accept it by pressing the <FUNCTION> key.

- Make sure the calibration jumper is in the position J10.
- Power cycle the instrument.

Warning:

New settings will not be stored unless saved in non volatile memory

10. Error Messages Table

Error:	Description:	Solution:
-E06-	The readings are not stable.	Retry an operation when the readings become stable.
-E07-	The initial load exceeds 10% of the maximum range.	Remove any load from the platform before turning on the instrument.
-E08-	Counting pieces resolution error occurred.	For the counting mode, mass of the single piece should represent at least 1/4 of the instrument minimum displayed division. Use heavier item for counting.
-E02-	Load exceeds the maximum measuring range of the instrument.	Remove heavy load from the platform.
-E01-	Incorrect tare value occurred.	Taring is only allowed for indication higher than zero. Use the<Tare> key to clear the previous tare while indication is below or equal to zero.

NOTES: